

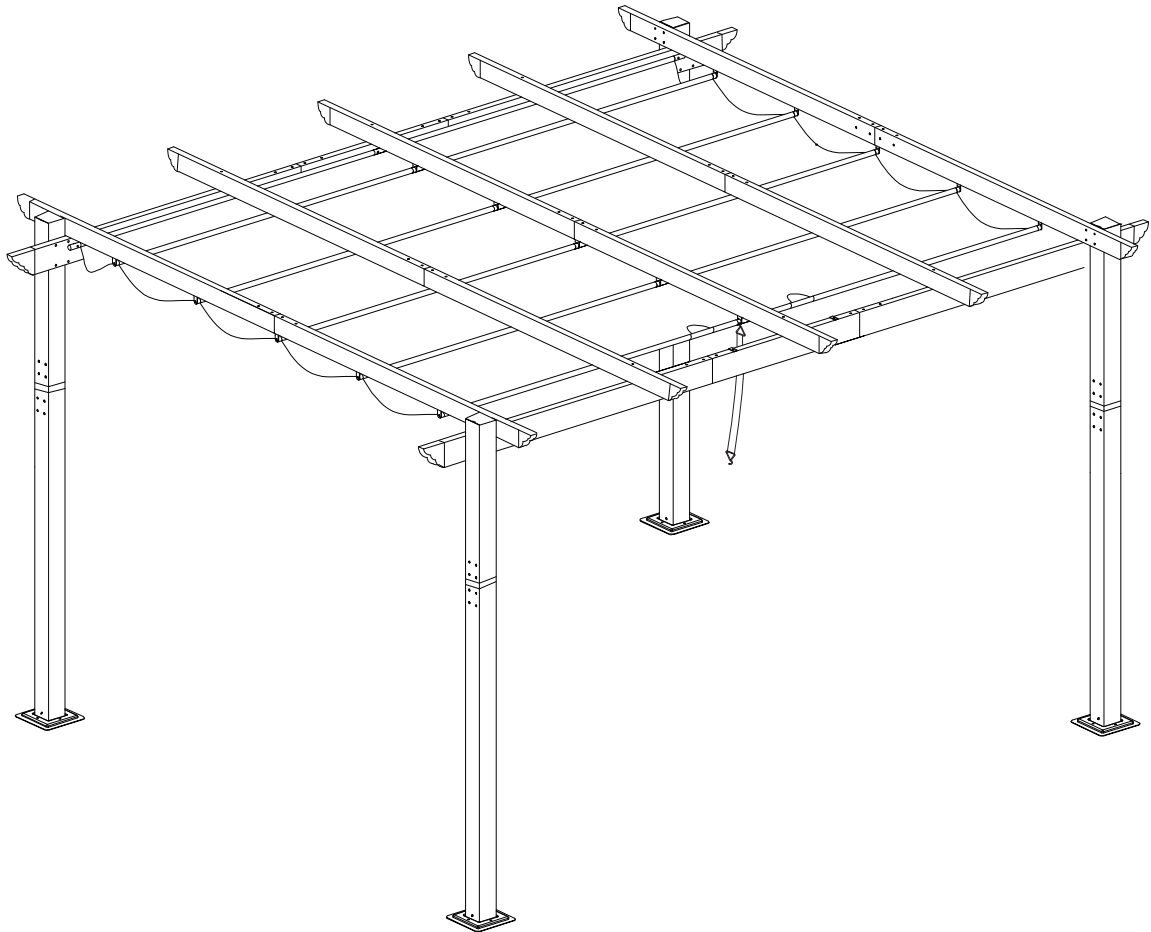

Enjoy Cozy Life!

MOGAN 10'X12' ALUMINUM PERGOLA ASSEMBLY MANUAL



KOZYARD LLC PRODUCTS

WWW.KOZYARD.COM

© Copyright 2016 - 2023 Kozyard LLC. | All Rights Reserved.
Version:20231006

Warnings and Cautions

- Please read and follow this assembly and operation guide to reduce the risk of personal injury and damage to your gazebo.
- Do not discard any of the packaging until you have checked that you have all the parts in place.
- Please close the Canopy, refraining from any damage in storm, snow, or bad weather.
- Some parts may have sharp edges or corners. To ensure your safety, follow basic safety precautions to reduce the risk of injury. Please note that this item contains small parts which could be swallowed by children. Keep it out of reach of children under 3 years old and pets during installation.



Two or more people are required for assembly and disassembly.



Do not fully tighten screw prior to complete assembly.

Pre-assembly

Tools that may be required.(Not included in boxes)

Note: Tools are not shown to actual size and scale.



Level



Phillips Screw



Drill



Allen Key







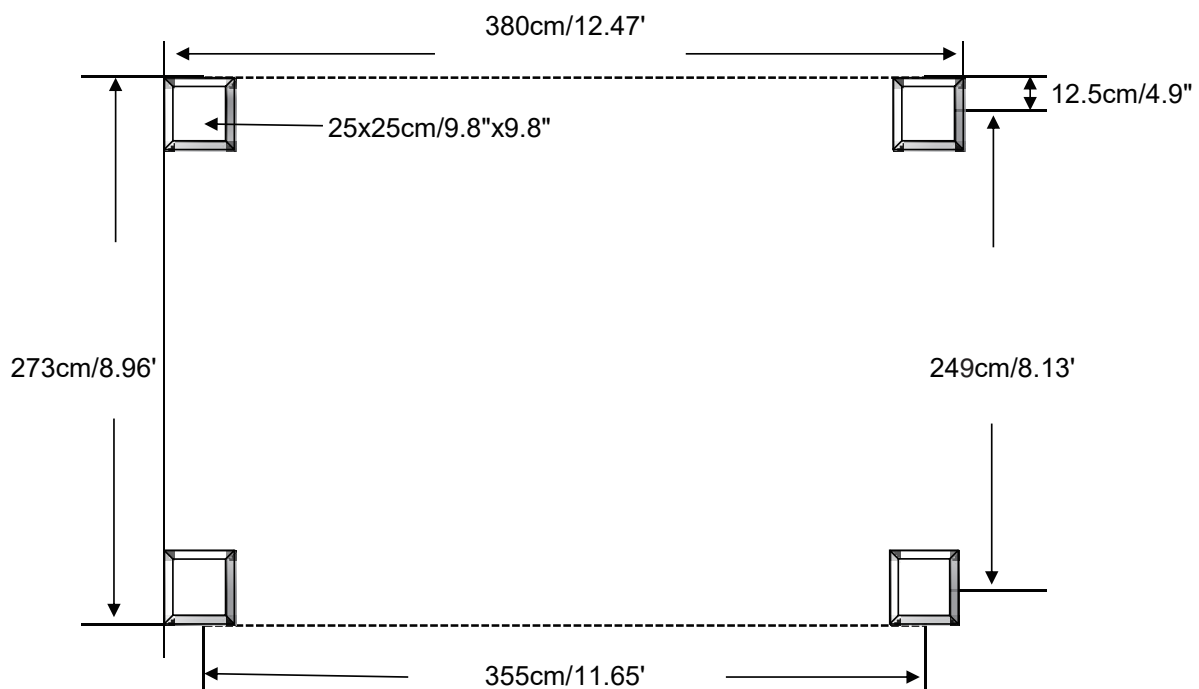



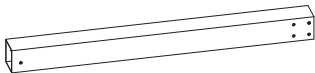



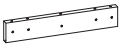

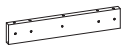



Stepladder







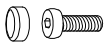

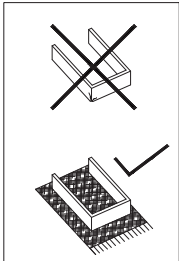
10'X13' Pergola anchore blueprint

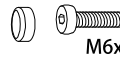

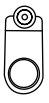
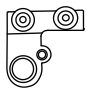
Attention: Prior to assembly, verify that all parts and pieces are included to ensure an efficient installation process.

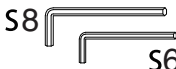

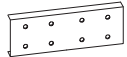
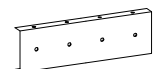

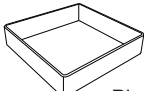

Parts list		A 4X Pole		1 or 3 Position Short Pole		A2 2X 2 or 4 Position Short Pole
		B 1X Side Tube		B1 1X Side Tube		
		B2 1X Side Middle Tube		C 1X Side Tube		
		C1 1X Side Tube		C2 1X Side Middle Tube		
		D 2X Side Track Tube		D1 2X Side Track Tube		
		E 1X Middle Track Tube		E1 1X Middle Track Tube		
		F 2X Beam Tube		F1 2X Beam Tube		
		G 1X Still Round Tube		G1 1X Still Round Tube		
		H 5X Moveable Round Tube		H1 5X Moveable Round Tube		
		I 4X Plate		J 154X+5X Bolt	M6x16	

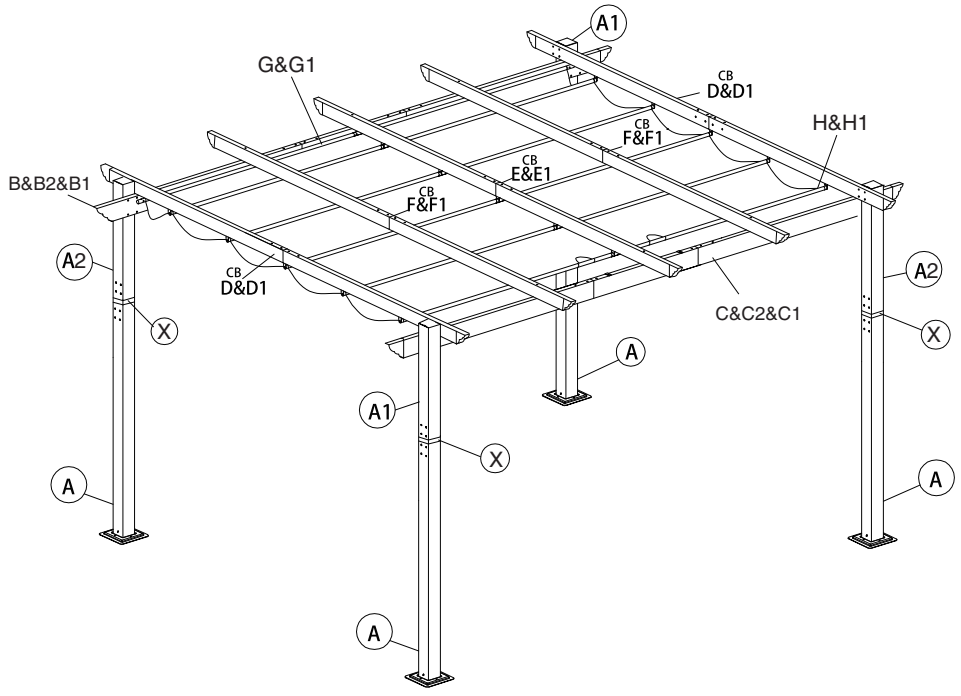

 M6x30 Bolt (K) 3X+1X	 M6x85 Bolt (L) 6X+1X	 M6x15 Bolt (M) 32X+2X	 (N) 10X Hook
 (O) 4X Hook	 (P) 1X Hook	 (R) 2X Lock	 (S) 1X Canopy
 S8 S6 Allen Key (Q) 1X	 Ribbon (T) 1X	 (U) 16x+2x	 Connector (V) 8x
 Connector (V1) 4x	 Connector (V2) 5x	 Plastic Cover (X) 4x	

OVERALL

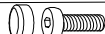

-  (A) 4X
-  (A1) 2X
-  (A2) 2X
-  (X) 4X
-  (V) 8X
-  (J) 64X
M6x 16
-  (Q) 1X
S6

Step 1:

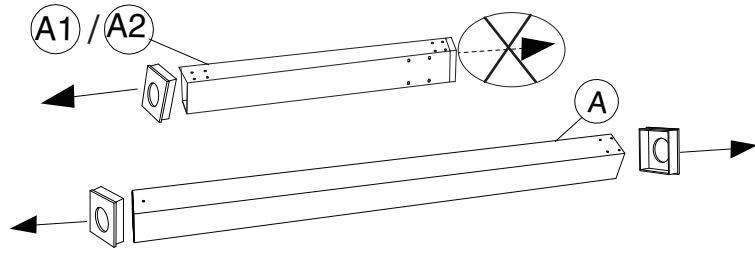

First, remove the plastic plugs from Part A1/A2 and Part A.

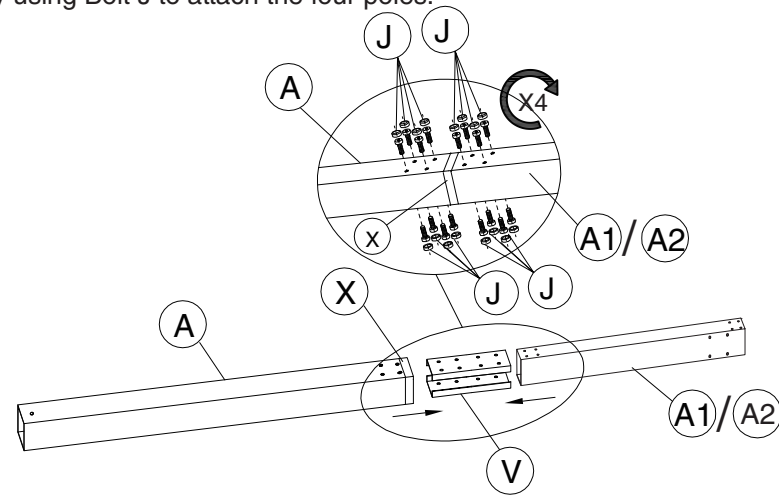

Then, place Part X on the four poles (Part A) and connect A and (A1 or A2) by using Bolt J to attach the four poles.



Do not tighten the bolts too much when inserting A into A1 and A2.

-  (I) 4X
-  (J) 8X
M6x 16
-  (Q) 1X
S6

Step 2:

Connect Part I to the poles using Bolt J.

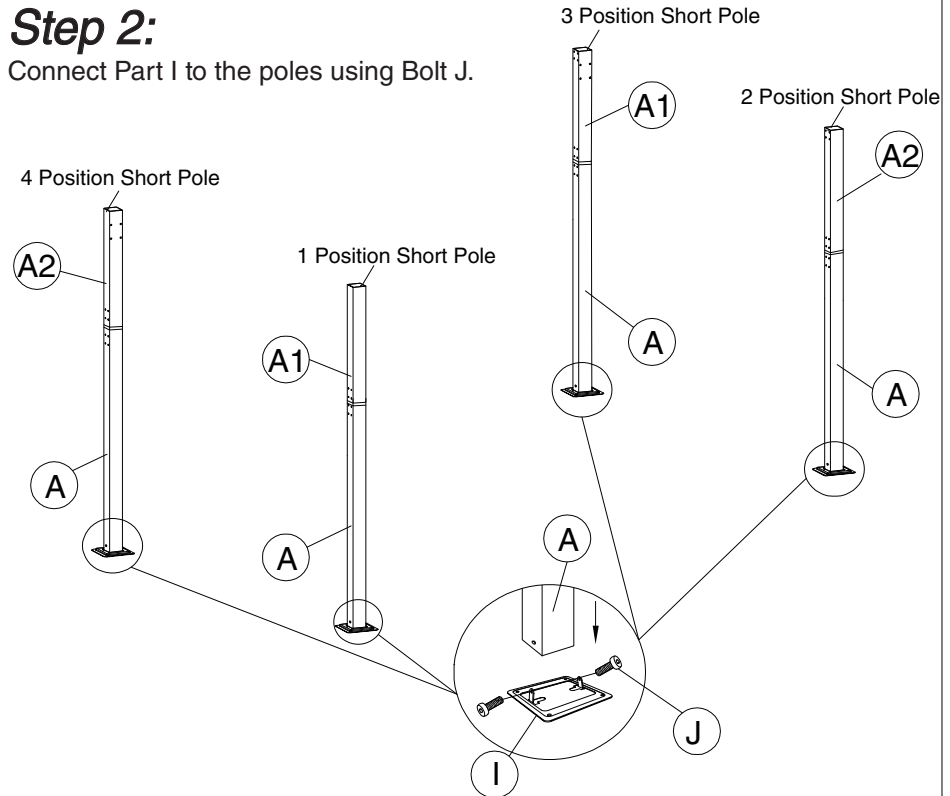

Step 3:

Connect Part B, Part B1, Part B2 using Bolt J to assemble Main Beam 1.

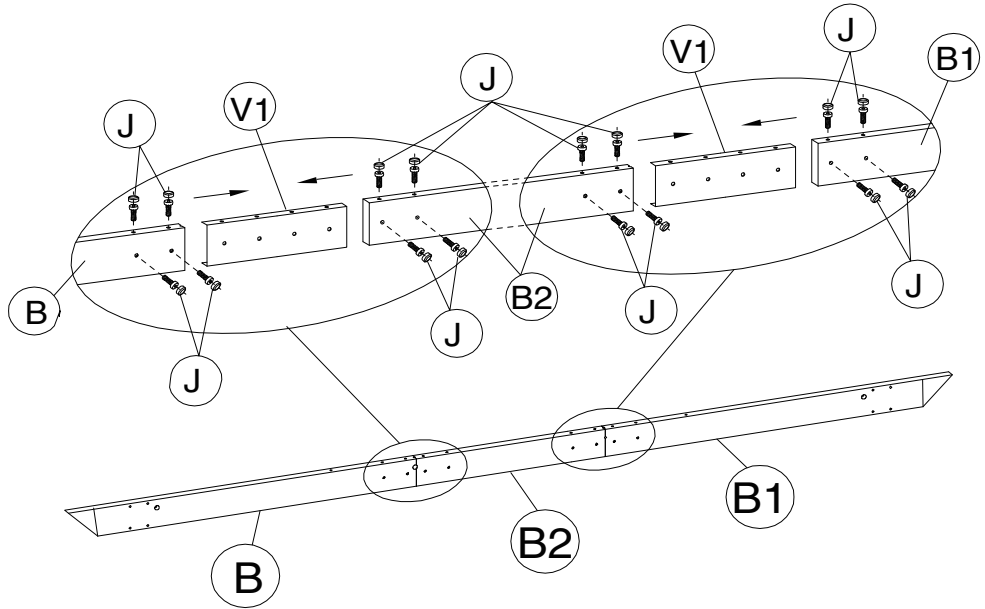

Connect C, C1, C2 using Bolt J to assemble Main Beam 2. Simultaneously, attach Part R to C2 using Bolt J.

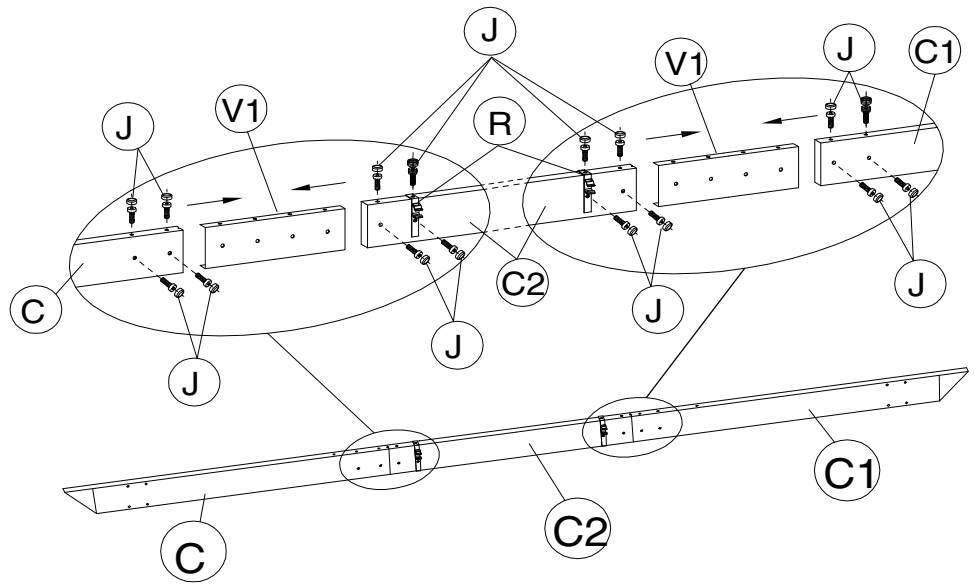

(B) 1X



(B1) 1X



(B2) 1X



(C) 1X



(C1) 1X



(C2) 1X



(R) 2X

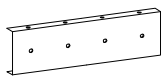

(V1) 4x

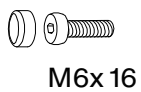

(J) 32X

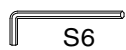

(Q) 1X

M6x15

(M) 16X

S8

(Q) 1X

Step 4:

Connect Main Beam 1 and Main Beam 2 to the Poles using Bolt M.

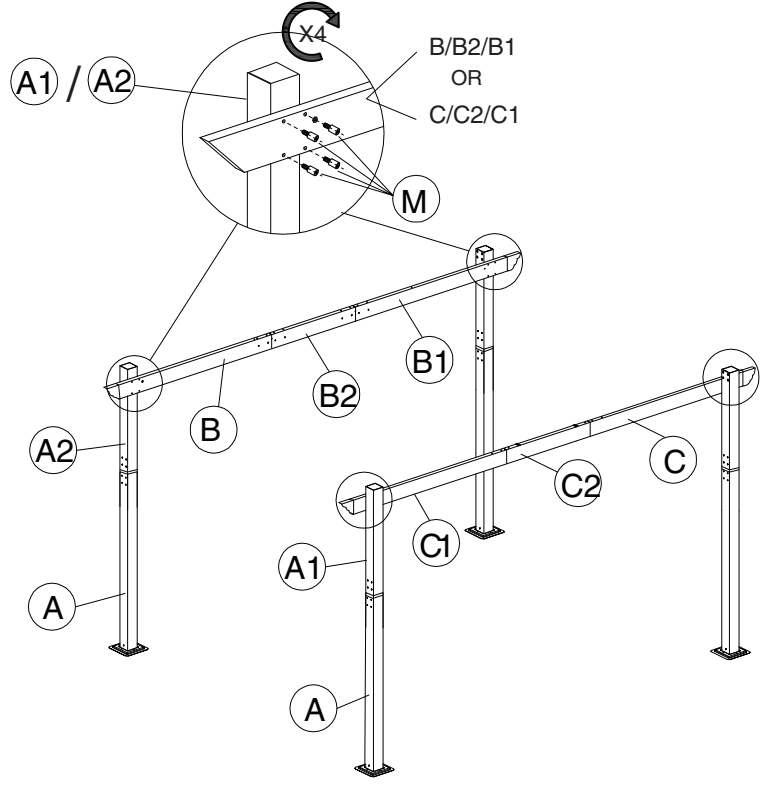

(D) 2X

(E) 1X

(N) 10X

(O) 4X

(P) 1X

Step 5:

1. Insert Hook Part N into the slot of Part D. Repeat twice.

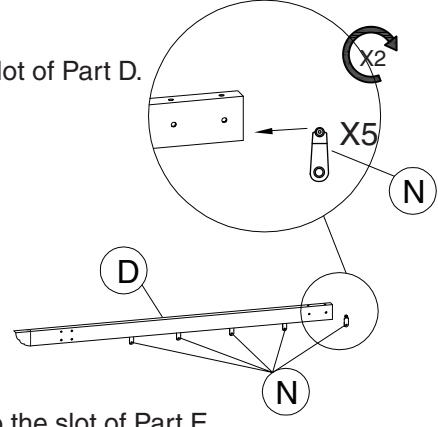

2. Insert Hook P and Hook O into the slot of Part E.

- Please ensure that Hook P is inserted according to the method shown in the diagram and not the opposite way.

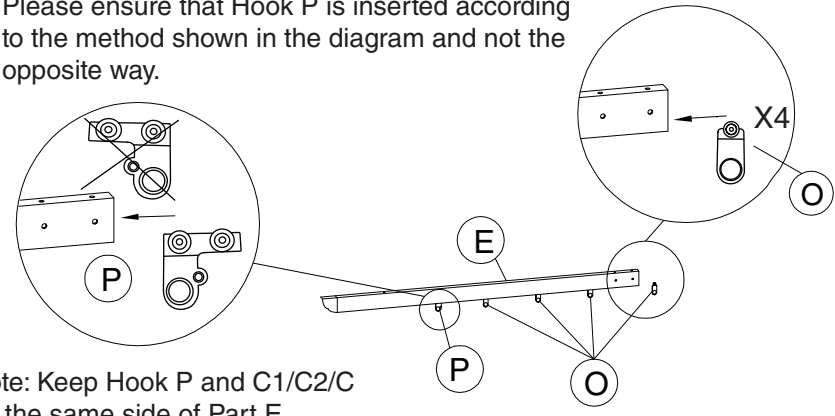

Note: Keep Hook P and C1/C2/C on the same side of Part E.



D 2X



D1 2X



V2 2x

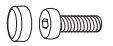

M6x16

J 16X



S6

Q 1X

Step 6:

Connect D and D1 to assemble the Cross Beam (D and D1) using Bolt J.

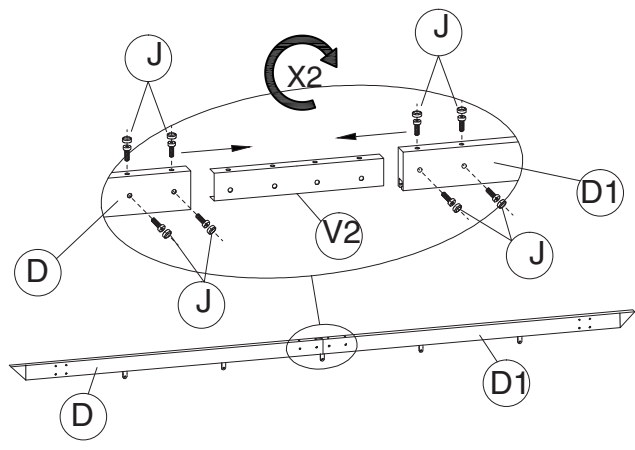

M6x15

M 16X

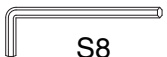





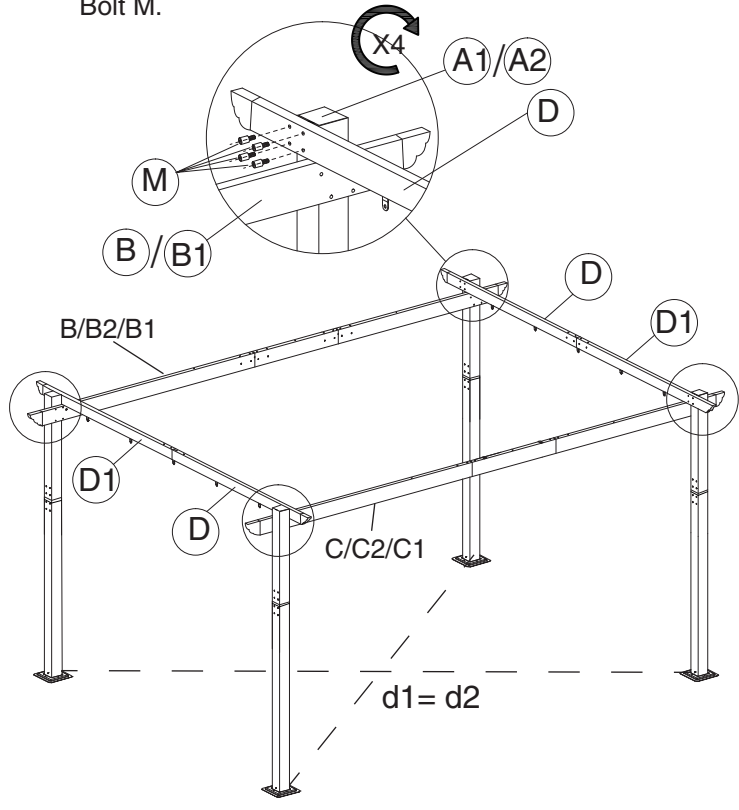

S8

Q 1X

Step 7:

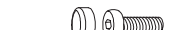

Connect the Cross Beam (D and D1) to the four Poles using Bolt M.

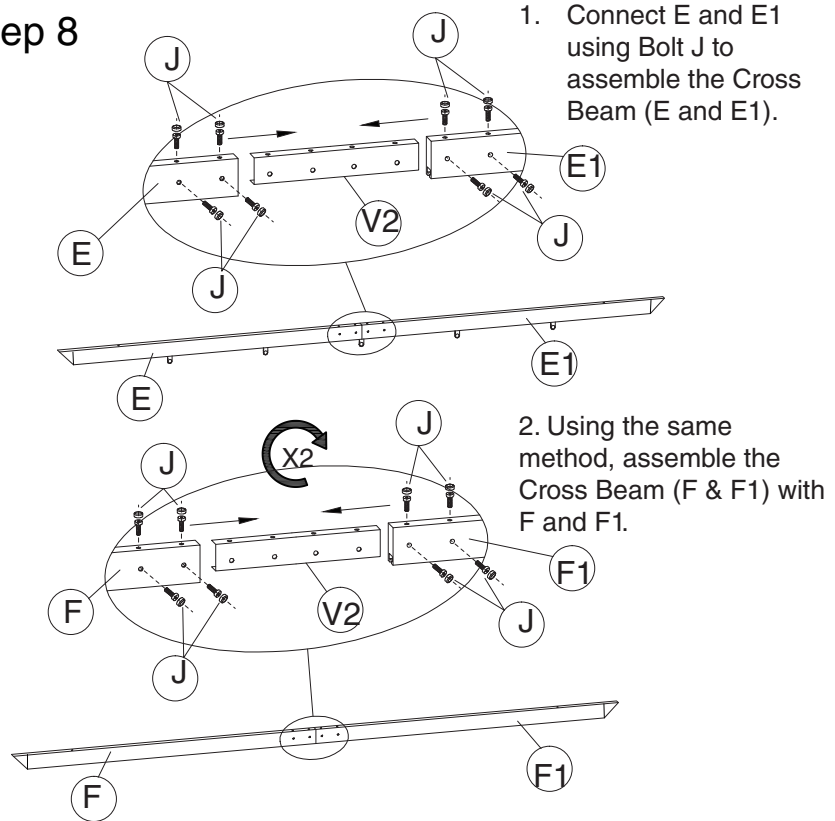

	E 1X
	E1 1X
	F 2X
	F1 2X
	J 24X M6x16
	Q 1X S6
	V2 3X

Step 8

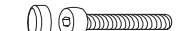

	L 6X M6x85
	Q 1X S6

Step 9: Connect the Cross Beams (E and E1) and (F and F1) to Main Beams 1 and 2. Please ensure that Hook P and C/C1 remain on the same side.

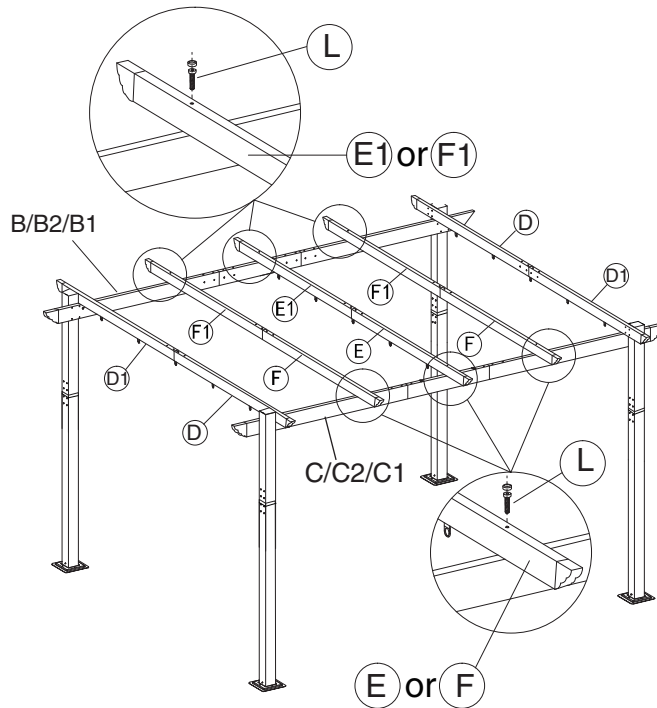

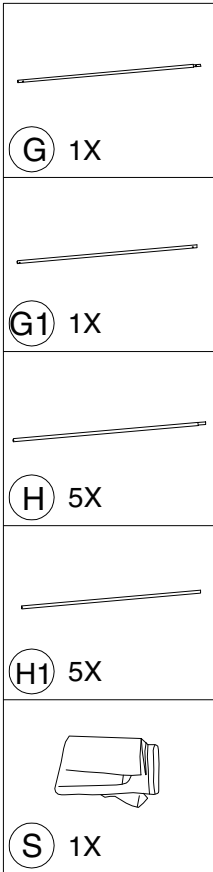

Step 10:

Insert G, G1, H, and H1 into the canopy from the side.

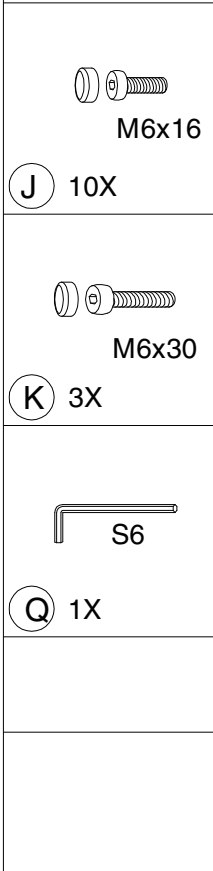
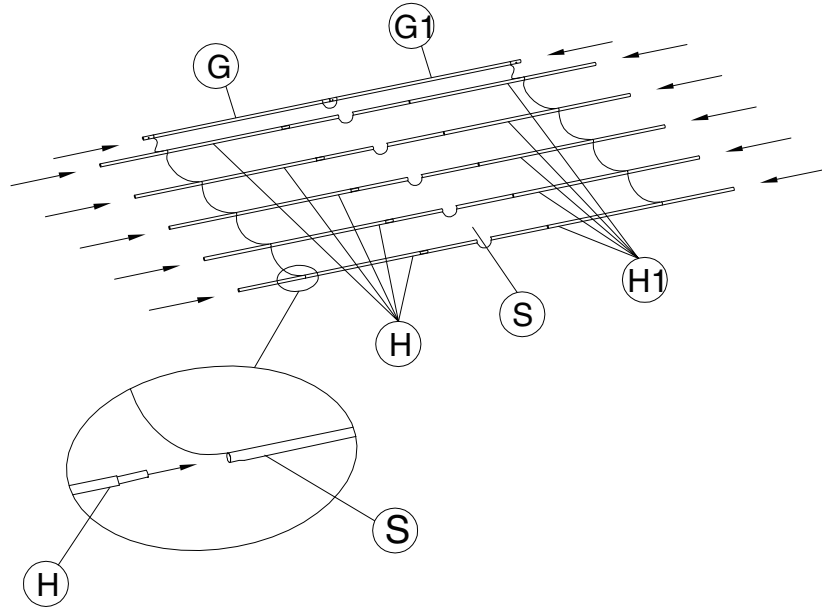

Step 11:

Connect G and G1 to B and B1 using bolt K, and secure the canopy with the frames.

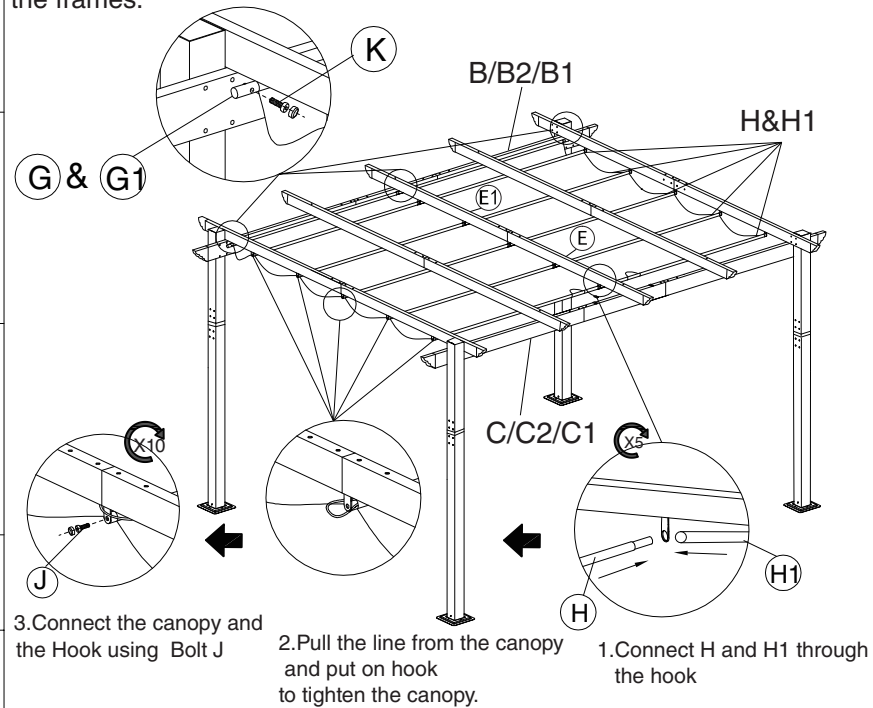

T 1X

Step 12:

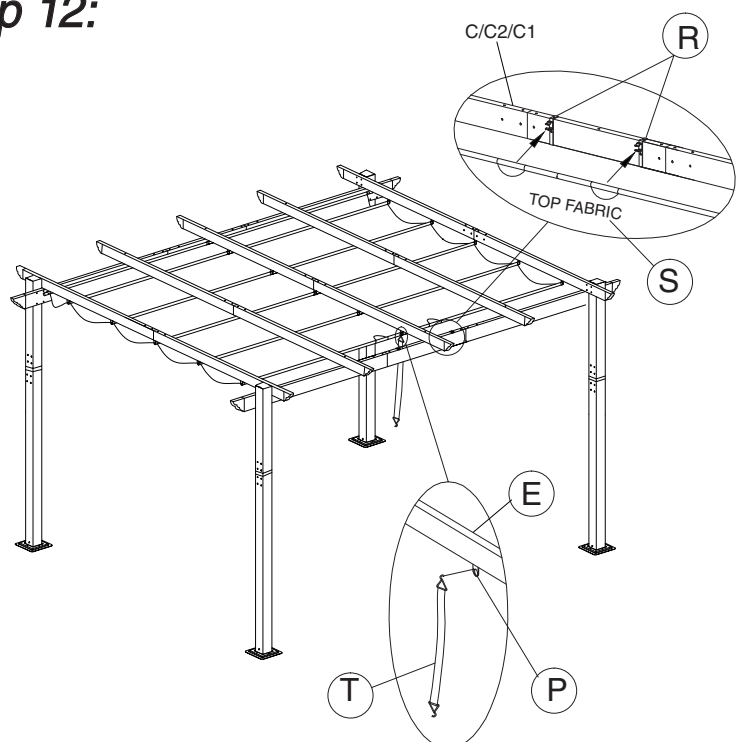

Hang Part T on Hook P

Step 13:

Secure Part T to beam B/B1 to attach the Top Fabric.

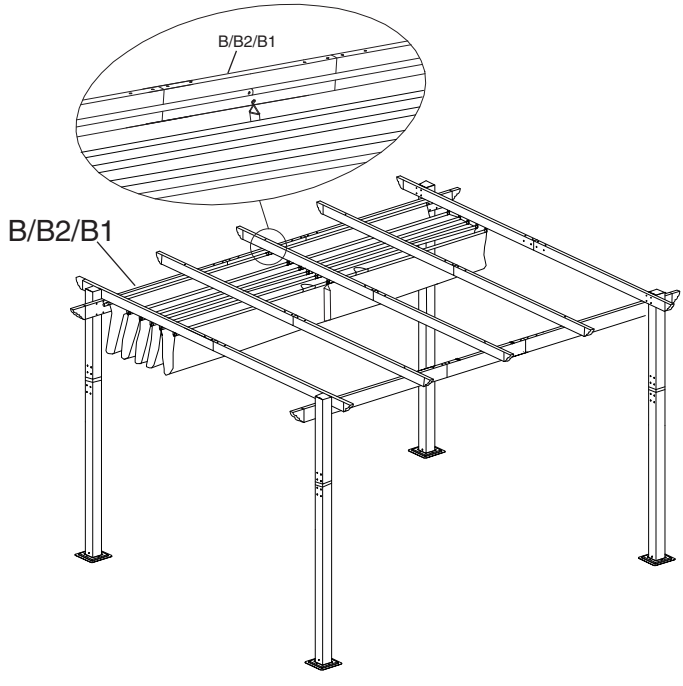

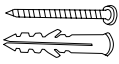

U 16X

Step 14:

Secure Foot I to the ground using Part U.

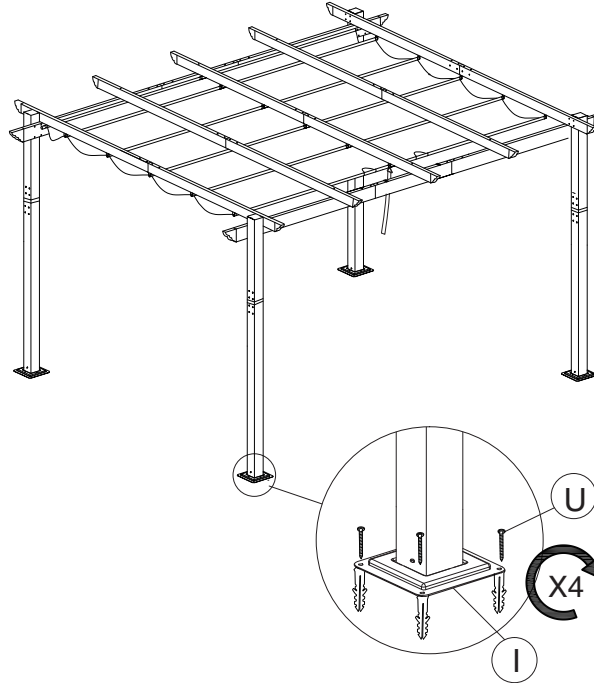

Step 15:

Before use, ensure that all screws are completely tightened.

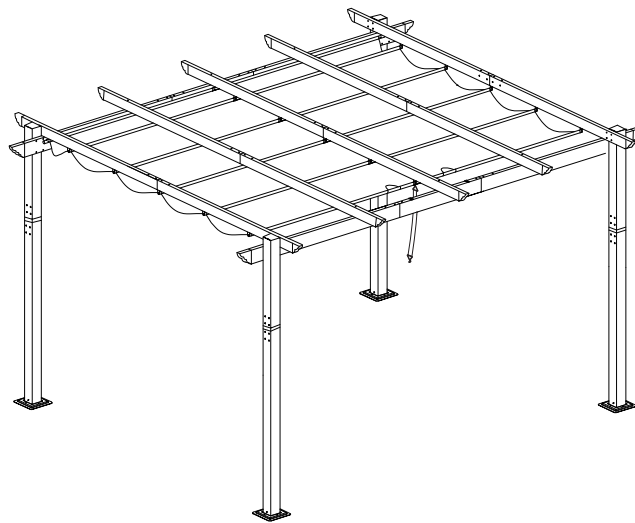

Care and Warranty

- Clean the frame components and fabric with a mild soap solution, then rinse thoroughly. Avoid using bleach, acid, or any other solvents on either the fabric or frame components.
- The roof, frame, bolts, and nuts come with a guarantee against defects in material and workmanship for one year from the date of purchase. However, the privacy curtain and mosquito netting are warranted for just 90 days. For a comprehensive warranty policy, please visit www.kozyard.com. Be aware that warranty terms can change without prior notification.
- For the best performance and safety of your pergola, inspect and tighten all bolts and fasteners regularly



Enjoy Cozy Life!

As expert manufacturer of hardtop gazebos, Kozyard remains committed to supporting you with parts and replacements, even beyond your warranty period.

Don't hesitate to contact us directly if you are missing parts or need a replacement.

SUPPORT:

Toll free: 1-866-355-0018

www.kozyard.com

email: support@kozyard.com

SOCIAL MEDIA:



Follow us on Instagram

www.instagram.com/kozyard

KOZYARD LLC