



CANTILEVER UMBRELLA ASSEMBLY AND OPERATION MANUAL



KOZYARD LLC PRODUCTS

WWW.KOZYARD.COM

Copyright 2016 - 2023 Kozyard LLC. | All Rights Reserved.
Version:20231006

ATTENTION PLEASE!

Read and follow this assembly and manual carefully.

To reduce personal injury and damage to your umbrella, please close your umbrella when wind is over 30mph.

We recommend a two-person team for assembly and disassembly.

If you like our products, please share your experience by writing a review or share in social media.

If you have any issue with the product, please contact us at 1-800-355-0018, or email us at info@kozyard.com.

Kozyard LLC
10808 6th St, Unit 100
Rancho Cucamonga, CA 91730

CHECKLIST

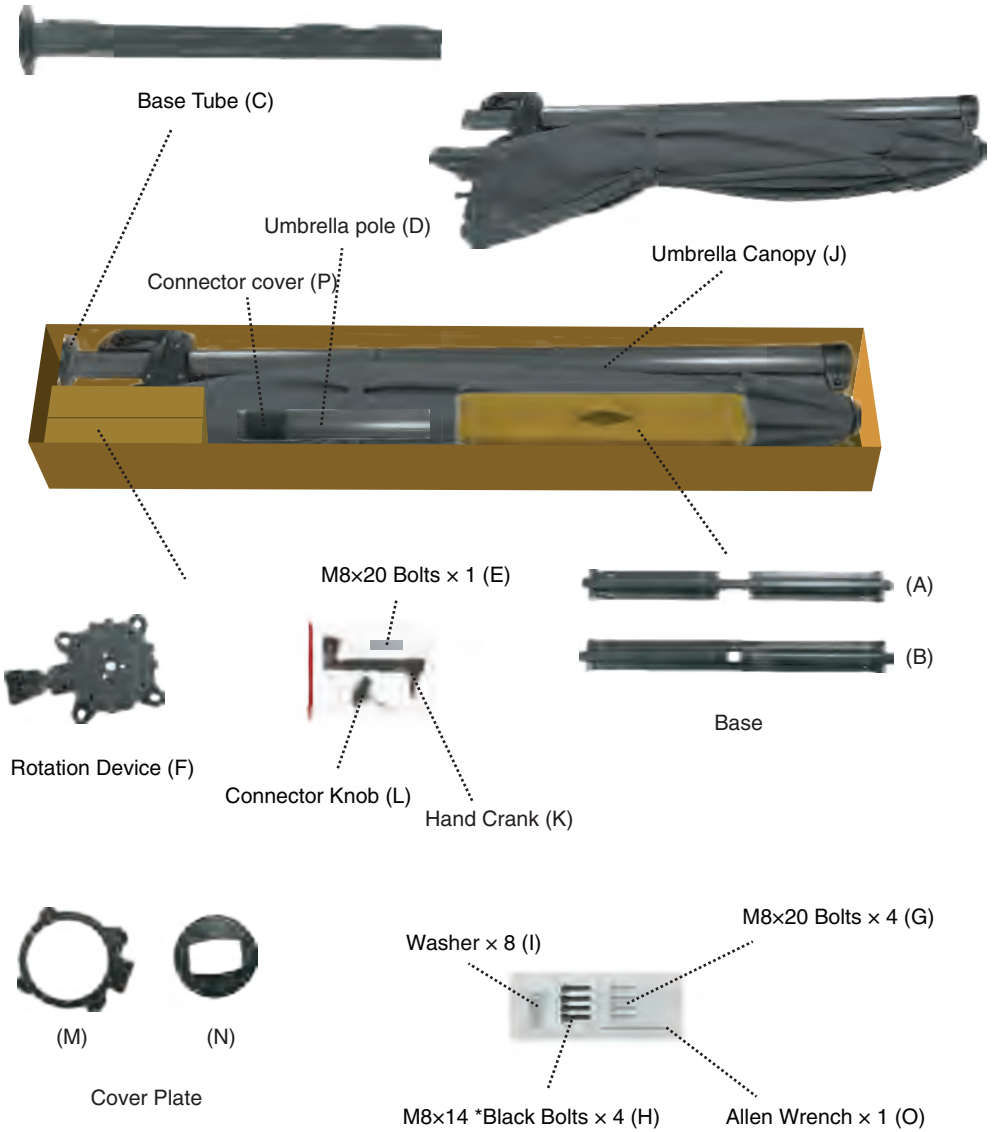

BASETUBE ASSEMBLY

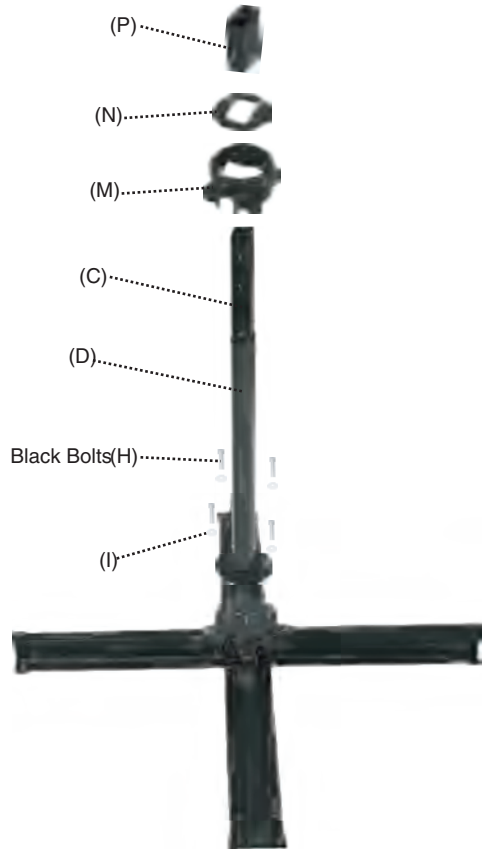
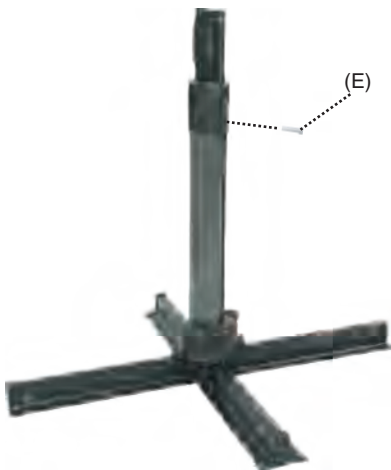
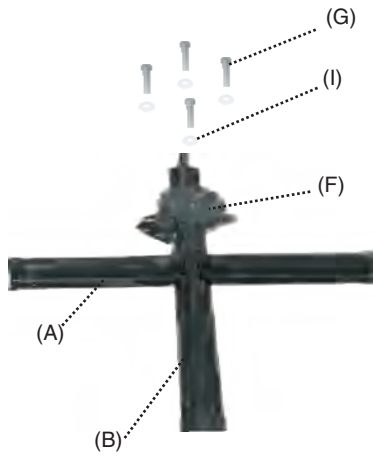

BASETUBE ASSEMBLY

IMPORTANT

Prior to assembly it is important to decide on the location of the umbrella.

- Allow ample height to avoid damage to your umbrella during assembly and usage.
- Choose a location that is level and sturdy.
- Consider a location that will maximize the umbrella's rotating swivel function. Placing the umbrella between two entertaining areas is ideal.
- To avoid personal injury or damage to the umbrella, make sure the area around you is clear from any outdoor structure or furniture.
- Keep all flame and heat sources away from this umbrella.

STORAGE: Properly store umbrella when not in use. Close umbrella, tie string around canopy.

NOTE: DO NOT discard any packaging or box until assembly is complete.

CAUTION: Moving the umbrella fully assembled will increase the risk of damage to your umbrella and/or can cause serious injury. We recommend a two-person team for assembly and disassembly.

UMBRELLA ASSEMBLY

Two-persons recommended for team lift and to complete assembly.

Insert the main pole into the base tube(C) installed.

Insert the connector knob (L) to the matched up holes.

Please Remove all of foam material from the frame before opening umbrella.

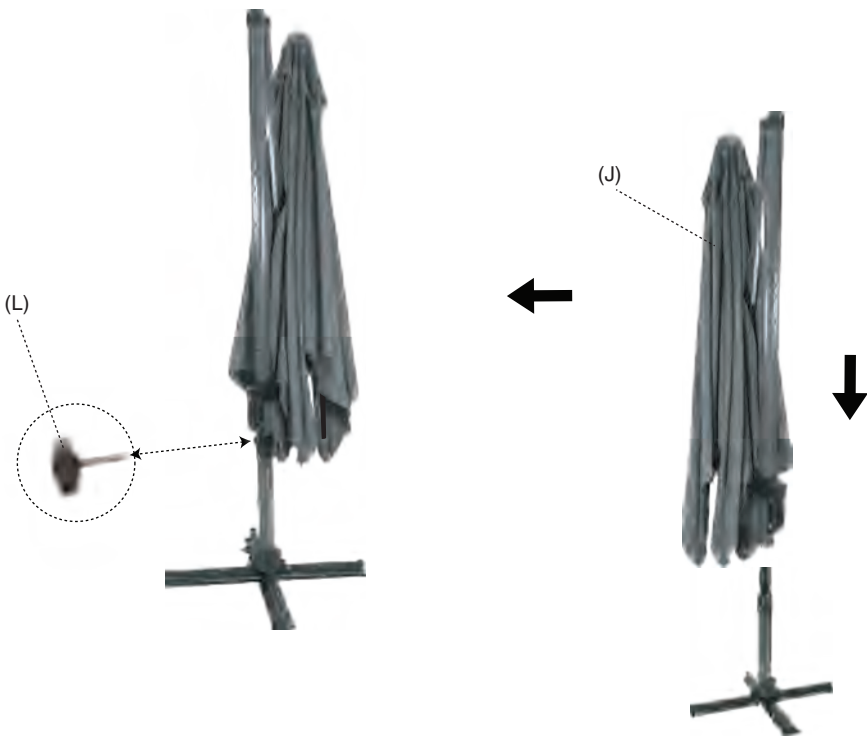

OPERATION

CAUTION

Stop turning the crank handle as soon as the umbrella cover is completely open and the sleeve on the umbrella pole has reached its maximum height.

IMPORTANT

PRIOR TO USING THE TILT FEATURE.
To avoid personal injury or damage to the umbrella, make sure the area behind you is clear and free from any furniture or structure.

OPERATION

To Open Canopy

1. Slide the umbrella handle to the top of the pole by squeezing the trigger.
2. Insert the hand crank(K) into the small hole of the handle on the post.



Squeeze the Trigger

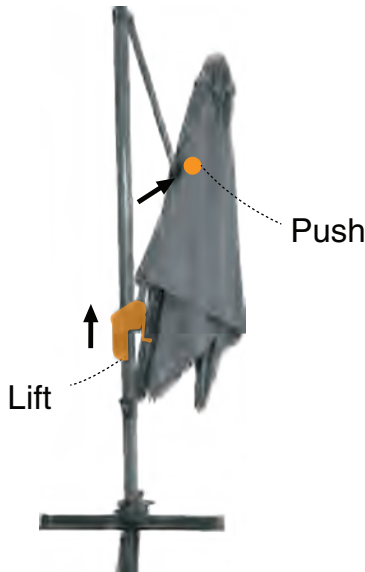

Be sure to remove all the protective material inside

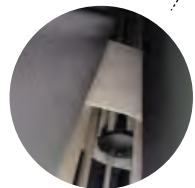

OPERATION

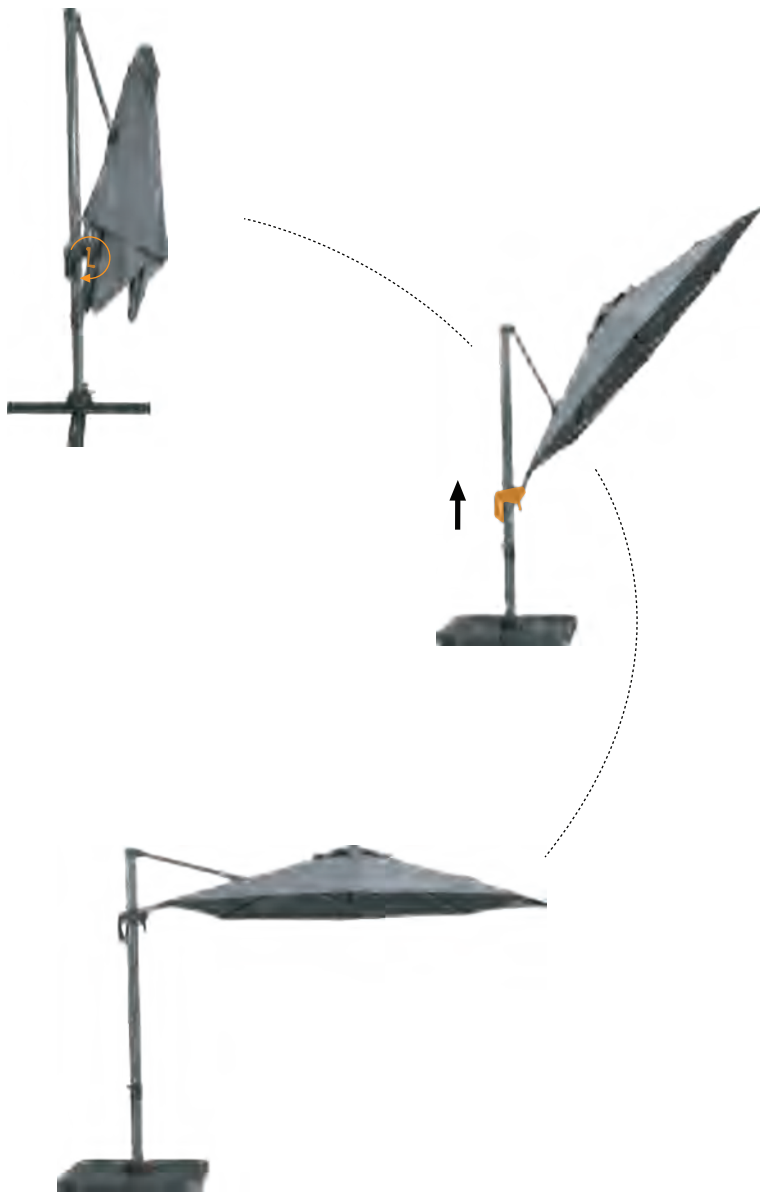

OPERATION

To Tilt Canopy

Press on the handle button and move the trigger handle up and down to adjust the angle of the umbrella canopy.

IMPORTANT: PRIOR TO USING THE TILT FEATURE.

To avoid personal injury or damage to the umbrella, make sure the area behind you is clear and free from any furniture or structure .



OPERATION

To Operate The 360° Rotation

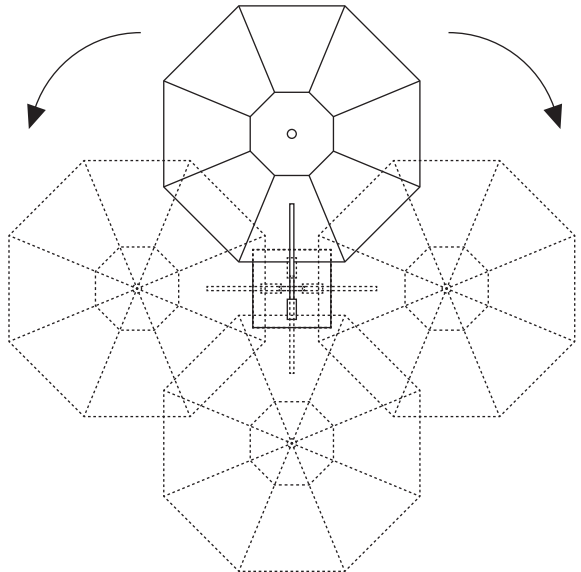

SAFETY PRECAUTIONS

Close the umbrella in windy conditions or when a storm approach.

Never allow the umbrella to flap in the wind; this could damage the canopy.

Properly store umbrella when not in use. Close umbrella, tie string around canopy.

Do not leave open umbrella unattended. If damage occurs, this is not covered by the warranty.

When adjusting the umbrella, make sure that no person(s) or item(s) are close to the umbrella. This is important to prevent injury or material damage.

Factory warranty does not cover the following items:

Failure caused by unreasonable or abusive use;

Failure caused by neglect of reasonable and necessary care;

Acts of nature (including but not limited to wind, hurricanes, tornadoes, and storms) are not covered by this warranty.

CARE AND MAINTENANCE

When not in use, close and cover umbrella with a protective cover.

If necessary, clean the fabric with lukewarm water.

Allow a wet canopy to dry slightly opened, but do not leave unattended.

Wipe sliding marks on the aluminum poles with a damp cloth.

Winter Storage: Store In A Dry Place.

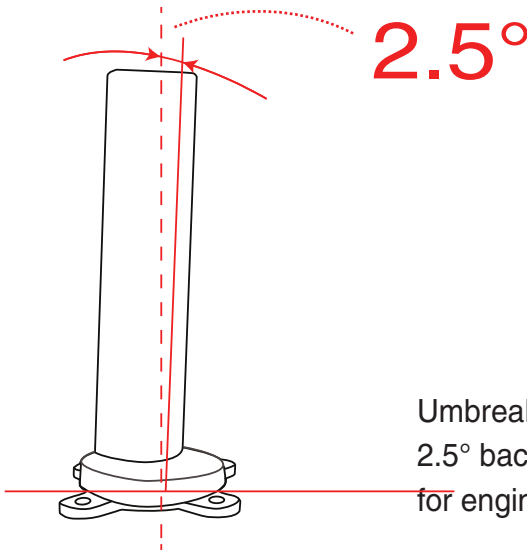

Umbrella base tube have 2.5° backward to the vertical for engineering purpose.



Enjoy Cozy Life!

SUPPORT:

Toll free : 866-355-0018

www.kozyard.com

email: support@kozyard.com

SOCIAL MEDIA:



Follow us on Instagram

www.instagram.com/kozyard

KOZYARD LLC