

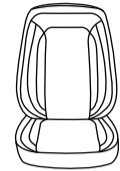





PART LIST

Before assembly please check all parts included as below

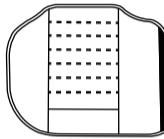
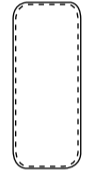
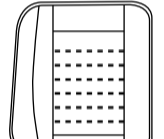
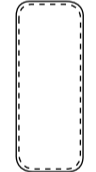
PARTS	DESCRIPTION	QTY
	Front seat cover	2
	Front head rest	2 (Half cover)
 For Nephela Style only		2 (Full cover)
	Rear seat (left+right)	1+1
	Rear seat connector	1
	Rear back(left+right)	1+1

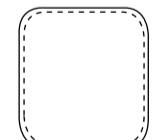
PARTS	DESCRIPTION	QTY
	Rear back connector	1
	Rear head rest cover	2
	Rear head rest cover (middle)	1
	Chuck	13
	Hook	8

1

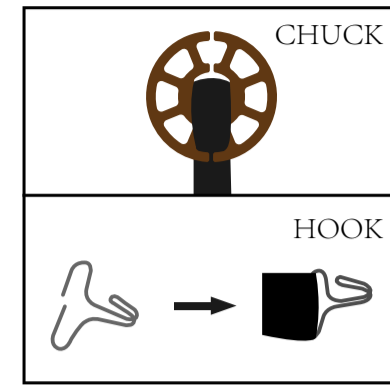

Chuck Instructions: Separate the elastic strap and pass it through the gap of the chuck, and then pass the upper and lower elastic strap together under the gap at the other end of the chuck.

Hook Instructions: Slightly separate the end of the hook, separate the elastic strap from the gap and put it into the end of the hook, and finally close the hook.

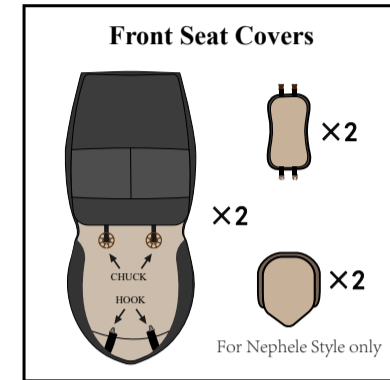

Extend the elastic strap on the back of the front seat cover, install the chuck on the elastic strap above the cushion, and install the hook on the elastic strap at the lower end of the cover.

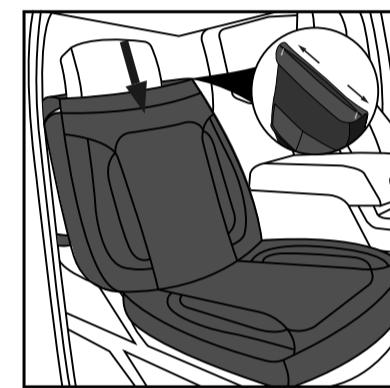

First open zipper on top of front seat cover, then put the cover into the seat as shown in diagram.

2

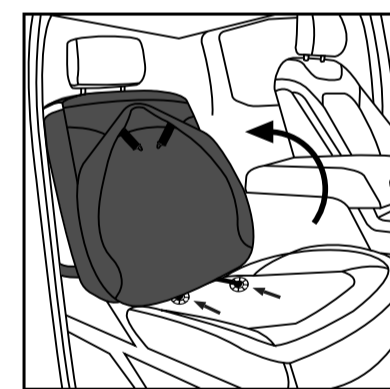

Lift seat cover, then put the chucks into seat gap.

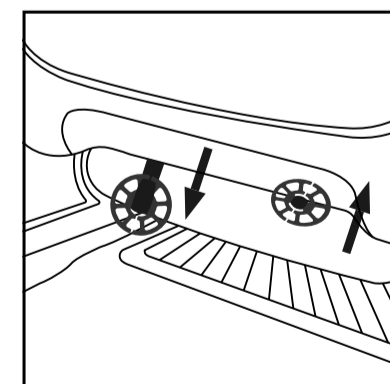

Pull the inserted chuck out of the back gap of the seat and adjust its position to fix it.

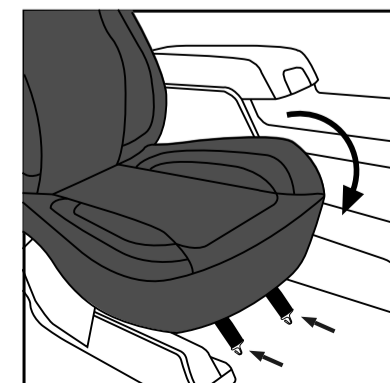

Insert the seat part of the front seat cover, Fasten hooks to proper place underneath as shown in diagram.

3

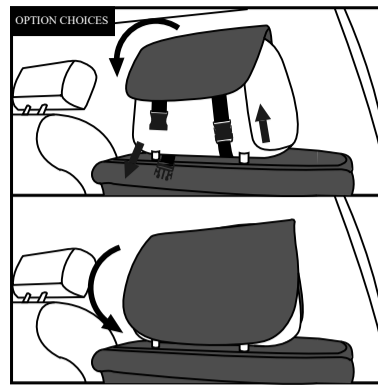

Wrap headrest then buckle them up as shown in diagram.

Adjust headrest cover to appropriate position as shown in diagram.

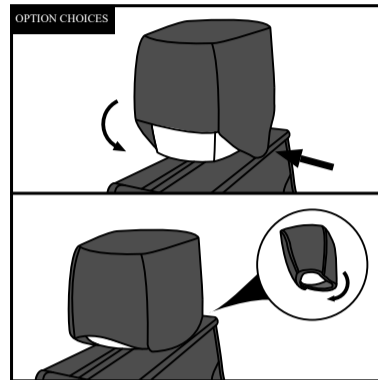

If this is Nephela style you will get an extra set of full headrest cover. Pull the cover as shown in diagram and adjust appropriate position as shown in diagram.

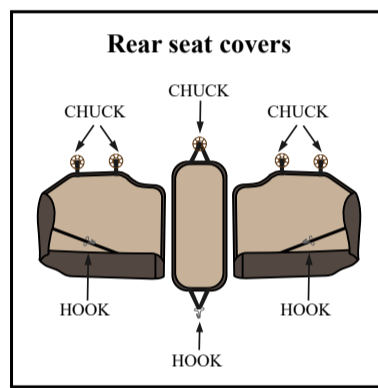

Install the elastic strap on the back of the rear seat part with accessories, the position is as shown in the figure.

5

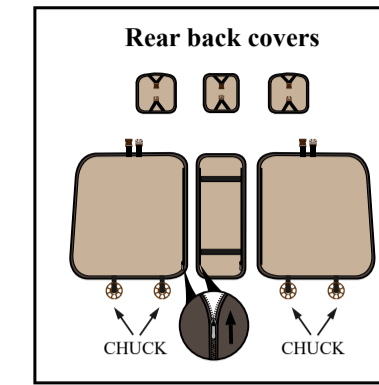

Installed the chucks on the elastic straps then connect all covers by zipper as shown in diagram.

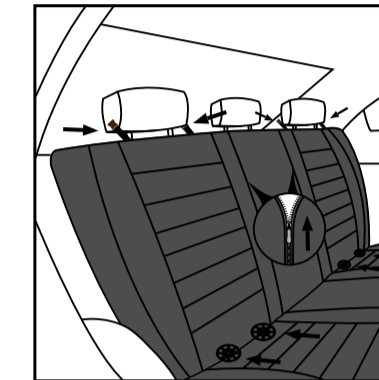

Cover the backrest part, insert the chucks into the seat gap, and put the upper end of the buckles respectively around the back of the headrest.

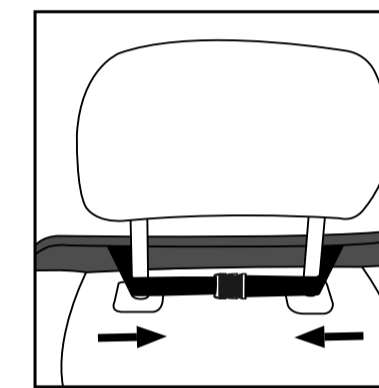

Fasten the buckles behind the headrest.

4

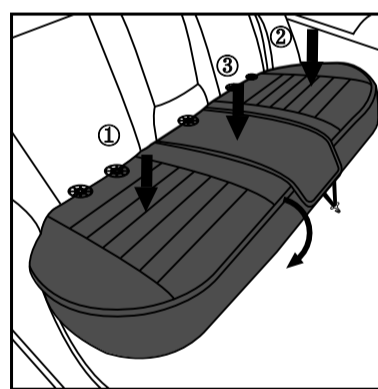

Place the seat cover on bottom seat according to the order sequence in the figure, and cover the lower part of the seat.

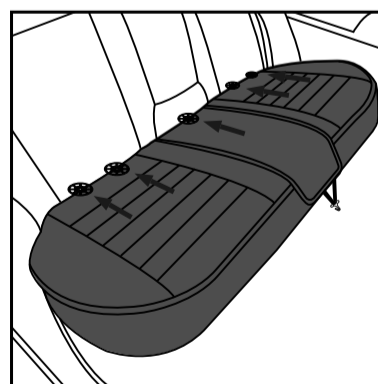

Insert the chuck of the seat cover into the gap of the seat connection.

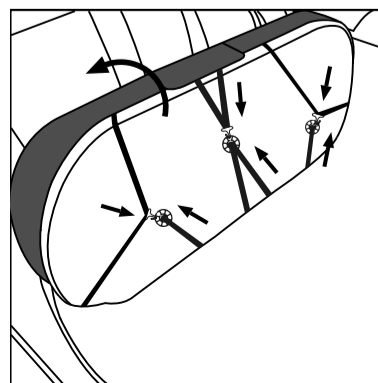

Lift the rear seat and hook the chuck on the upper part of the seat cover with the hook under the seat cover.

6

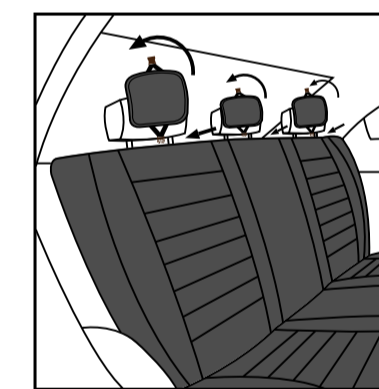

Wrap headrest then buckle them up as shown in diagram.

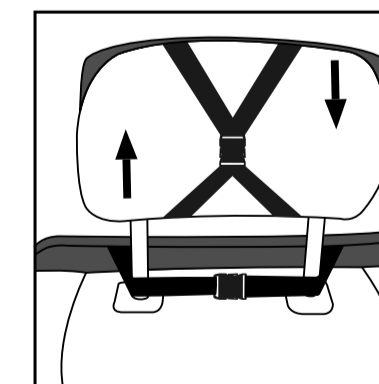

Adjust headrest cover to appropriate position as shown in diagram.

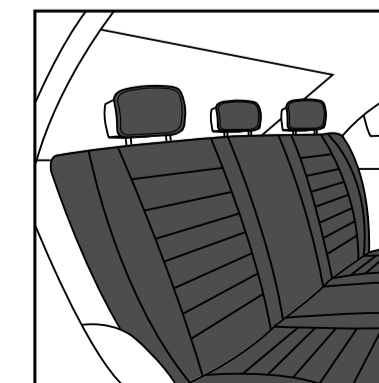

Congratulations The full auto seat cover is completely installed.

Should you experience any difficulty during assembly or if any parts is missing or damaged, contact our customer service by email: info@kozayard.com or call toll free: 866-355-0018.

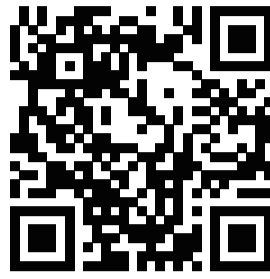

scan the QRcode for assembly video

ASSEMBLY INSTRUCTION

UNIVERSAL AUTO SEAT COVER

TOMIC AUTO

